

0.6" SERIES OUTPUT MODULES



- AC Modules have High Current Thyristors with 100 Amp Surge Capability
- Plug into mounting boards for 0.6" modules
- Zero or Random Turn-On Available in AC Modules
- 4kV Optical isolation (1500 VAC Isolation for FET DC Output Modules)
- UL Recognized, CSA Certified, CE Compliant
- Industry standard packaging and Color Coding
Black (AC Output) Red (DC Output)

SPECIFICATIONS (1)

Input

Part Number	OAC5	OAC5A	OAC5AH	OAC5AR	OAC5R	OAC24
Nominal Voltage VDC	5.0	5.0	5.0	5.0	5.0	24
Minimum Voltage VDC (2)	2.75	2.75	2.75	2.75	2.75	18
Maximum Voltage VDC	8.0	8.0	8.0	8.0	8.0	32
Drop-out Voltage	1.0	1.0	1.0	1.0	1.0	1.0
Maximum Current (3)	20	20	20	20	20	13
Resistance (4)	220	220	220	220	220	2000

Output

Nominal Line Voltage	120 VAC	240 VAC	240 VAC	240 VAC	120 VAC	120 VAC
Minimum Line Voltage	12 VAC	24 VAC	24 VAC	24 VAC	12 VAC	12 VAC
Maximum Line Voltage	140 VAC	280 VAC	280 VAC	280 VAC	140 VAC	140 VAC
Max Off-State Voltage (5)	400 Vpeak	600 Vpeak	600 Vpeak	600 Vpeak	400 Vpeak	400 Vpeak
Max Off-State Leakage (6)	0.1mArms	0.1mArms	0.1mArms	0.1mArms	0.1mArms	0.1mArms
Static Off-State dv/dt (7)	200 V/usec	200 V/usec	200 V/usec	200 V/usec	200 V/usec	200 V/usec
Maximum Rated On-State Current (8)	3.5 Arms	3.5 Arms	5.0 Arms	3.5 Arms	3.5 Arms	3.5 Arms
Minimum On-State Current	50 mArms	50 mArms	50 mArms	50 mArms	50 mArms	50 mArms
Max Surge Current (9)	100 Apeak	100 Apeak	100 Apeak	100 Apeak	100 Apeak	100 Apeak
On-State Voltage Drop or Resistance (10)	1.6 V	1.6 V	1.6 V	1.6 V	1.6 V	1.6 V
Maximum Turn-On Time [msec] (13)	8.33	8.33	8.33	0.1	0.1	8.33
Maximum Turn-Off Time [msec] (13)	8.33	8.33	8.33	8.33	8.33	8.33
Input/Output Isolation Voltage (14)	4000	4000	4000	4000	4000	4000
Input/Output Capacitance	8	8	8	8	8	8
Operating Temperature Range	-30 to 80°C	-30 to 80°C	-30 to 80°C	-30 to 80°C	-30 to 80°C	-30 to 80°C
Storage Temperature Range	-40 to 80°C	-40 to 80°C	-40 to 80°C	-40 to 80°C	-40 to 80°C	-40 to 80°C
Line Frequency Range	47 to 63	47 to 63	47 to 63	47 to 63	47 to 63	47 to 63
Weight	1.1 oz. (31.2g)	1.1 oz. (31.2g)	1.1 oz. (31.2g)	1.1 oz. (31.2g)	1.1 oz. (31.2g)	1.1 oz. (31.2g)

Input

Part Number	OAC24A	ODC5	ODC5A	ODC5F	ODC5MA
Nominal Voltage VDC	24	5.0	5.0	5.0	5.0
Minimum Voltage VDC (2)	18	2.75	2.75	2.75	2.75
Maximum Voltage VDC	32	8.0	8.0	8.0	8.0
Drop-out Voltage	1.0	1.0	1.0	1.0	1.0
Maximum Current (3)	13	18	18	18	18
Resistance (4)	2000	250	250	250	250

Output

Nominal Line Voltage	240 VAC	5-48 VDC	5-150 VDC	5-48 VDC	5-150 VDC
Minimum Line Voltage	24 VAC	3.0 VDC	3.0 VDC	3.0 VDC	1.0 VDC
Maximum Line Voltage	280 VAC	60 VDC	250 VDC	60 VDC	200 VDC
Max Off-State Voltage (5)	600 Vpeak	60 VDC	250 VDC	60 VDC	200 VDC
Max Off-State Leakage (6)	0.1mArms	10 uA	10 uA	10 uA	10 uA
Static Off-State dv/dt (7)	200 V/usec	N/A	N/A	N/A	N/A
Maximum Rated On-State Current (8)	3.5 Arms	3.0 A	1.0 A	3.0 A	3.0 A
Minimum On-State Current	50 mArms	10 mA	10 mA	10 mA	1.0 mA
Max Surge Current (9)	100 Apeak	5.0 A	5.0 A	5.0 A	10 A
On-State Voltage Drop or Resistance (10)	1.6 V	1.5 V	1.5 V	1.5 V	0.25 Ohms
Maximum Turn-On Time [msec] (13)	8.33	0.1	0.1	0.025	1.0
Maximum Turn-Off Time [msec] (13)	8.33	0.75	0.75	0.05	0.05
Input/Output Isolation Voltage (14)	4000	4000	4000	4000	1500
Input/Output Capacitance	8	8	8	8	8
Operating Temperature Range	-30 to 80°C	-30 to 80°C	-30 to 80°C	-30 to 80°C	-30 to 80°C
Storage Temperature Range	-40 to 80°C	-40 to 80°C	-40 to 80°C	-40 to 80°C	-40 to 80°C
Line Frequency Range	47 to 63	DC	DC	DC	DC
Weight	1.1 oz. (31.2g)	1.1 oz. (31.2g)	1.1 oz. (31.2g)	1.1 oz. (31.2g)	1.1 oz. (31.2g)

Input

Part Number	ODC5MC	ODC5ML	ODC24	ODC24A	ODC24F
Nominal Voltage VDC	5.0	5.0	24	24	24
Minimum Voltage VDC (2)	2.75	2.75	18	18	18
Maximum Voltage VDC	8.0	8.0	32	32	32
Drop-out Voltage	1.0	1.0	1.0	1.0	1.0
Maximum Current (3)	18	18	13	13	13
Resistance (4)	250	250	2000	2000	2000

Output

Nominal Line Voltage	5-90 VDC	5-48 VDC	5-48 VDC	5-150 VDC	5-48 VDC
Minimum Line Voltage	1.0 VDC	1.0 VDC	3.0 VDC	3.0 VDC	3.0 VDC
Maximum Line Voltage	100 VDC	50 VDC	60 VDC	250 VDC	60 VDC
Max Off-State Voltage (5)	50 VDC	60 VDC	250 VDC	60 VDC	60 VDC
Max Off-State Leakage (6)	10 uA	10 uA	10 uA	10 uA	10 uA
Static Off-State dv/dt (7)	N/A	N/A	N/A	N/A	N/A
Maximum Rated On-State Current (8)	5.0 A	1.0 A	3.0 A	1.0 A	3.0 A
Minimum On-State Current	1.0 mA	10 mA	10 mA	10 mA	10 mA
Max Surge Current (9)	10 A	10 A	5.0 A	5.0 A	5.0 A
On-State Voltage Drop or Resistance (10)	0.10 Ohms	0.05 Ohms	1.5 V	1.5 V	1.5 V
Maximum Turn-On Time [msec] (13)	1.0	1.0	0.1	0.1	0.025
Maximum Turn-Off Time [msec] (13)	0.05	0.05	0.75	0.75	0.05
Input/Output Isolation Voltage (14)	1500	1500	4000	4000	4000
Input/Output Capacitance	8	8	8	8	8
Operating Temperature Range	-30 to 80°C	-30 to 80°C	-30 to 80°C	-30 to 80°C	-30 to 80°C
Storage Temperature Range	-40 to 80°C	-40 to 80°C	-40 to 80°C	-40 to 80°C	-40 to 80°C
Line Frequency Range	DC	DC	DC	DC	DC
Weight	1.1 oz. (31.2g)	1.1 oz. (31.2g)	1.1 oz. (31.2g)	1.1 oz. (31.2g)	1.1 oz. (31.2g)

GENERAL NOTES

General Notes:

- (1) Specifications apply to an ambient temperature of -30 to 80 °C unless otherwise noted.
- (2) Without external LED status indicator. Add 1.7 volts for external LED if utilized.
- (3) At nominal input voltage, without external LED status indicator.
- (4) +/-10% at 25°C.
- (5) Maximum 1 minute duration for OAC modules when applied as a DC voltage rather than a peak AC voltage.
- (6) At maximum line voltage, 25°C for OAC modules, and 80°C for ODC modules.
- (7) Minimum DV/DT per EIA/NARM RS433, method RS397, DV/DT ratings do not apply to DC output models
- (8) At 40°C, derate OAC modules 58 mA/°C to 80°C, derate ODC, ODCxMC and ODCxML modules 50 mA/°C to 80°C. CSA rating of OAC modules is 3.0 Arms at 40°C.
- (9) At 25°C for 1 second maximum duration: 1 AC cycle for AC modules, 1 second for DC modules.
- (10) At maximum rated on-state current and 25°C.
- (11) At maximum line voltage, maximum rated output current, nominal input voltage and 25° C. Switching speed of OAC modules is based upon 60 Hz line frequency.
- (12) At 25°C for 1 second maximum duration.
- (13) 1/3 H.P. at 240 VAC, 1/8 H.P. at 120 VAC.

MECHANICAL SPECIFICATIONS

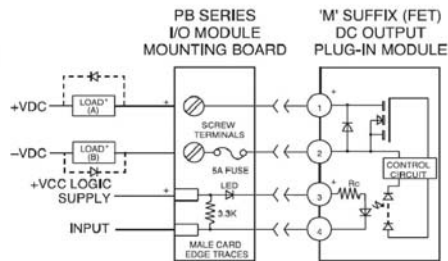
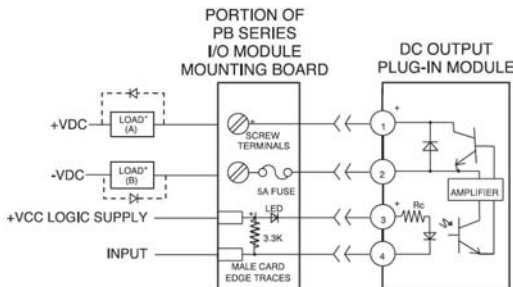
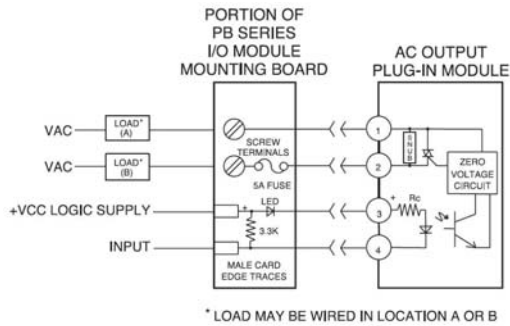

* LOAD MAY BE WIRED IN LOCATION A OR B
DC INDUCTIVE LOADS MUST BE DIODE SUPPRESSED TO PREVENT DAMAGE TO THE I/O MODULE.

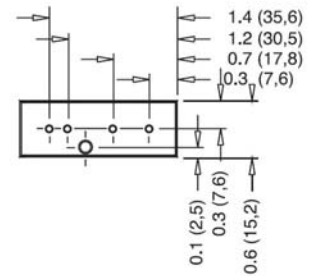
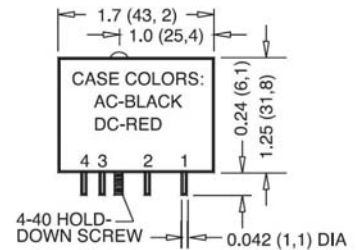

DIMENSIONS: INCHES (MILLIMETERS)
TOLERANCE: ±0.020 (±0,50)

AGENCY APPROVALS

- UL
- CSA
- CE

 DANGER / PELIGRO / DANGER /GEFAHR / PERICOLO / PERIGO					
<p>HAZARD OF ELECTRIC SHOCK, EXPLOSION, OR ARC FLASH.</p> <ul style="list-style-type: none"> Disconnect all power before installing or working with this equipment. Verify all connections and replace all covers before turning on power. <p>Failure to follow these instructions will result in death or serious injury.</p>	<p>RIESGO DE DESCARGA ELECTRICA O EXPLOSION.</p> <ul style="list-style-type: none"> Desconectar todos los suministros de energia a este equipo antes de trabajar con este equipo. Verificar todas las conexiones y colocar todas las tapas antes de energizar el equipo. <p>EI incumplimiento de estas instrucciones puede provocar la muerte o lesiones serias.</p>	<p>RISQUE DE DESCARGE ELECTRIQUE OU EXPLOSION</p> <ul style="list-style-type: none"> Eteindre toutes les sources d'énergie de cet appareil avant de travailler dessus de cet appareil Vérifier tous connections, et remettre tous couverts en olace avant de mettre sous <p>De non-suivi de ces instructions provoquera la mort ou des lésions sérieuses sérieuses.</p>	<p>GEFAHR EINES ELEKTRISCHE N SCHLAGES ODER EINER EXPLOSION.</p> <ul style="list-style-type: none"> Stellen Sie jeglichen Strom ab, der dieses Gerät versorgt, bevor Sie an dem Gerät Arbeiten durchführen Vor der Inbetriebnahme alle Anschlüsse überprüfen und alle Gehäuseteile montieren. <p>Unterlassung dieser Anweisungen können zum Tode oder zu schweren Verletzungen führen.</p>	<p>RISCHIO DI SCOSSA ELETTRICA O DELL'ESPLOSIONE.</p> <ul style="list-style-type: none"> Spenga tutta l'alimentazione e che fornisce questa apparecchiatura prima del lavorare a questa apparecchiatura Verificare tutti i collegamenti e sostituire tutte le coperture prima della rotazione sull'alimentazione <p>L'omissione di seguire queste istruzioni provocherà la morte o di lesioni serie</p>	<p>RISCO DE DESCARGA ELÉTRICA OU EXPLOÇÃO</p> <ul style="list-style-type: none"> Desconectar o equipamento de toda a energia antes de instalar ou trabalhar com este equipamento Verificar todas as conexões e recolocar todas as tampas antes de religar o equipamento <p>O não cumprimento destas instruções pode levar à morte ou lesões sérias.</p>

 WARNING / AVERTISSEMENT / WARNUNG /ADVERTENCIA / AVVERTENZA / AVISO		
<p>RISK OF MATERIAL DAMAGE AND HOT ENCLOSURE</p> <ul style="list-style-type: none"> The product's side panels may be hot, allow time for product to cool before touching. Follow proper mounting instructions including torque values. Do not allow liquids or foreign objects to enter this product. <p>Failure to follow this instruction can result in serious injury, or equipment damage.</p>	<p>RISQUE DE DOMMAGE MATERIEL ET DE SURCHAUFFE DU BOITIER</p> <ul style="list-style-type: none"> Les panneaux latéraux du produit peuvent être chauds. Laisser le produit refroidir avant de le toucher. Respecter les consignes de montage, et notamment les couples de serrage. Ne pas laisser pénétrer de liquide ni de corps étrangers à l'intérieur du produit. <p>Le non-respect de cette directive peut entraîner, des lésions corporelles graves ou des dommages matériels.</p>	<p>GEFAHR VON MATERIALSCHÄDEN UND GEHÄUSEERHITZUNG</p> <ul style="list-style-type: none"> Die Seitenwände können heiß sein. Lassen Sie das Produkt abkühlen, bevor Sie es berühren. Beachten Sie die Montageanweisungen, Führen Sie keine Flüssigkeiten oder Fremdkörper in das Produkt ein. <p>Die Nichtbeachtung dieser Anweisung kann Körperverletzung oder Materialschäden zur Folge haben.</p>
<p>RIESGO DE DAÑOS MATERIALES Y DE SOBRECIENTAMIENTO DE LA UNIDAD</p> <ul style="list-style-type: none"> Los paneles laterales del producto pueden estar calientes. Esperar que el producto se enfríe antes de tocarlo. Respetar las instrucciones de montaje, y en particular los pares de apretado. No dejar que penetren líquidos o cuerpos extraños en el producto. <p>Si no se respetan estas precauciones pueden producirse graves lesiones, daños materiales.</p>	<p>RISCHIO DI DANNI MATERIALI E D'INVOLUCRO CALDO</p> <ul style="list-style-type: none"> I pannelli laterali dell'apparecchio possono scottare; lasciar quindi raffreddare il prodotto prima di toccarlo. Seguire le istruzioni di montaggio corrette. Non far entrare liquidi o oggetti estranei in questo apparecchio. <p>La mancata osservanza di questa precauzione può causare gravi rischi per l'incolumità personale o danni alle apparecchiature.</p>	<p>RISCO DE DANO MATERIAL E DE AQUECIMENTO</p> <ul style="list-style-type: none"> Os painéis laterais do produto podem estar quentes; dê tempo ao produto para arrefecer antes de lhe tocar. Siga devidamente as instruções de montagem. Não permita a entrada de líquidos e de objectos estranhos no produto. <p>A não observância destas precauções pode provocar a morte, ferimentos graves ou danos materiais.</p>

The environmental information disclosed in this annex including the EIP Pollution logo are in compliance with People's Republic of China Electronic Industry Standard SJ/T11364 – 2006, Marking for Control of Pollution Caused by Electronic Information Products.

Part Name	Toxic or hazardous Substance and Elements					
	Lead (Pb)	Mercury (Hg)	Cadmium (Cd)	Hexavalent Chromium (Cr (VI))	Polybrominated biphenyls (PBB)	Polybrominated diphenyl ethers (PBDE)
Semiconductor die	X	0	0	0	0	0
Solder	X	0	0	0	0	0

此附件所标示的包括电子信息产品污染图标的环保信息符合中华人民共和国电子行业标准 **SJ/T11364 - 2006**, 电子信息产品污染控制标识要求



部件名称	有毒有害物质或元素					
	铅 (Pb)	汞 (Hg)	镉 (Cd)	六价铬 (Cr (VI))	多溴联苯 (PBB)	多溴二苯醚 (PBDE)
半导体芯片	X	0	0	0	0	0
焊接点	X	0	0	0	0	0